

Detection system with temperature in a room using Arduino

by Irzal Arief Wisky

Submission date: 22-Sep-2023 03:04PM (UTC+0700)

Submission ID: 2173464728

File name: Sinkron_Artikel.pdf (597.59K)

Word count: 2797

Character count: 14699

Detection system with temperature in a room using Arduino

Riandana Afira^{1)*}, Pradani Ayu Widya Purnama²⁾, Teri Ade Putra³⁾, Irzal Arief Wisky⁴⁾

¹⁾²⁾³⁾⁴⁾Universitas Putra Indonesia YPTK Padang
¹⁾riandanaafira@gmail.com, ²⁾pradaniwid@gmail.com, ³⁾teriputra2@gmail.com, ⁴⁾irzal.arief12@gmail.com.

Submitted : Mar 21, 2022 | Accepted : Mar 31, 2022 | Published : Apr 1, 2022

Abstract: In this era, all agencies, be it companies, offices, and industries, take advantage of technological developments with computerized systems. This progress gives an important role in human life. Currently, computers are not only used to process data, they can even be used to control an electronics-based system, such as in the field of controlling external equipment, controlling robots, electronic equipment, and so on. Along with the development of these technologies, the authors try to develop a type of electronic component, namely the LM35DZ Temperature Sensor and Arduino. This research was conducted to create a system that can measure temperature in a room using Arduino and the LM35DZ temperature sensor as the main components. This LM35DZ temperature sensor functions to convert the temperature scale into an electrical quantity in the form of a voltage with a high level of precision but is very simple. Arduino functions as a central place for processing all data and instructions, so that it can facilitate the development of a microcontroller application, starting from writing source programs, complications, uploading complication results and testing serial terminals. The use of Arduino in this tool is combined with ATMEGA 328 and the source program used is the C programming language.

Keywords: Arduino; Temperature Sensor LM35DZ; LCD; ATMEGA 328; C programming

INTRODUCTION

Today the development of information and communication technology as well as science and technology (IPTEK) is growing very rapidly. All agencies, whether a company, office, industry and other environments, take advantage of technological developments with computerized systems. This progress gives an important role in human life. Currently computers are not only used to process data, they can even be used to control an electronics-based system, such as in the field of controlling external equipment, controlling robots, electronic equipment, moving conveyors and so on. Computer performance is strived to be maximized in helping human work, so that the ability and usability of the computer can be optimized.

Along with the development of these technologies, the authors try to develop a type of electronic component, namely the LM35DZ Temperature Sensor. LM35DZ temperature sensor is an electronic component that belongs to the same family as the LM35. It has a function to convert temperature into electrical quantities in the form of voltage.

Furthermore, the authors develop an electronic device that is Arduino. Arduino is an electronic device that makes it easy for us to develop a microcontroller application, starting from writing source programs, complexes, uploading the results of complications and testing in a serial terminal.

In daily activities, a person needs a comfortable place or room so that can concentrate on a particular area of work. The place of the environment can affect one of the comfort factors in the room for activities. The temperature and humidity in the room can affect the effectiveness of activities at work. Working at room temperature that is hot enough, of course, the body's physical ability decreases which causes fatigue and if the temperature in a room that is cold enough results in loss of motor flexibility in the body causing stiffness to the physical body.

The various advantages of the microcontroller and some reason above, can be used to make an instrument to measure room temperature. Maintaining room temperature is something that really needs to be

²
*name of corresponding author



¹
This is an Creative Commons License This work is licensed under a Creative Commons Attribution-NonCommercial 4.0 International License.

done, because manual temperature measurements are very time consuming and less efficient, so a temperature measuring instrument is needed more precise which can display the room temperature in real time.

By considering some of the things mentioned above, the author tries to apply the tool with ATMEGA 328 and the source program used is the C programming language.

LITERATURE REVIEW

ARDUINO

Arduino is a relatively easy and fast microcontroller system in making electronics and robotics applications. The proof is that there are several robotics courses that used to work on programming using AVR. Now it has used a programming language using arduino.

Arduino uses the AVR ATmega 328 chip which has PWM facilities, serial communication, ADC, timer, interrupt, SPI, I2C and a direct bootloader. So that Arduino can be combined directly with other modules or tools with different protocols. The source program used is the C programming language.



Fig.1. Arduino

LED (light Emitting Diode)

Most semiconductors emit light when energized. This burst of energy can occur in the form of electrons, light or heat. Light Emitting Diodes (Light Emitting Diode) use this property, where the LED is a diode mounted in a transparent case that will light up / emit light when a current is passed. By using elements such as: gelium, arsenic and phosphorus, it can be obtained LEDs that produce red light or invisible light.

When an LED is applied forward voltage, it will emit light because the free electrons will recombine with the holes around the junction as it moves from a higher energy level to a lower energy level.

These free electrons will release their energy in the form of radiation. Inside the LED some of this energy difference is released as light radiation. This voltage activates the LED ranging from 1.6 volts to 2.4 volts depending on the type. The current required is 15 mA. The cathode is a straight line, indicated by the shorter LED leg. For more details, you can see the symbol of the diode block of the diode in the picture:

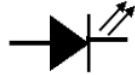

Fig.2. LED Symbol

LCD (Liquid Cristal Display)

The Character LCD module can be easily connected to a microcontroller such as the ATmega328. The LCD that we will practice has a display width of 2 rows and 16 columns or commonly referred to as a 2x16 Character LCD, with a 16 pin connector, which can be seen in the picture:



Fig.3. LCD Module

The character display on the LCD is set by the EN, RS and RW pins. The EN line is called Enable. This line is used to tell the LCD that you are sending data. To send data to the LCD, through the EN program, a logic low "0" must be made and set to the other two control lines, RS and RW. When the other two lines are

*name of corresponding author



This is an ¹ Creative Commons License This work is licensed under a Creative Commons Attribution-NonCommercial 4.0 International License.

ready, set EN to logic "1" and wait for a certain amount of time (according to the datasheet of the LCD) and then set EN to logic low "0" again.

The RS line is the Register Select line. When RS has a low logic "0", the data will be treated as a command or special instruction (such as clear screen, cursor position, etc.). When RS has a high logic "1", the data sent is text data which will be displayed on the LCD display. For example, to display the letter "T" on the LCD screen RS must be set to a logic high "1".

The RW line is the Read/Write control line. When RW is logic low (0), then the information on the data bus will be written on the LCD screen. When RW has a high logic "1", then the program will read the memory from the LCD. Whereas in general applications the RW pin is always given a low logic "0". In the end, the data bus consists of 4 or 8 lines (depending on the operating mode selected by the user). In the case of an 8-bit data bus, the lines are referred to as DB0 to DB7.

METHOD

Tool Physical Design

In general, the physical design of this tool can be grouped into several parts, namely:

- a. Arduino circuit.
- b. Power Supply Circuit.
- c. Relay Circuit.
- d. LCD.

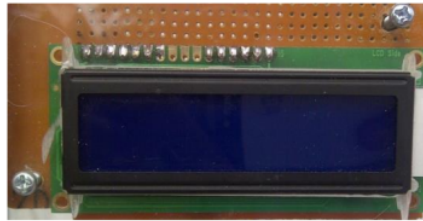

Fig.4. Phisycs

How the Tool Works

In the design of this tool, after the start button is pressed, the system will work automatically, where the system works without any control or control from outside the system, control of the entire system is carried out or controlled only through Arduino. Temperature settings are made in the program and the setting results will be displayed on the LCD and if the temperature is above the normal batten temperature limit then the fan will turn on. This control is carried out using a program that has been loaded on the Arduino which works in the presence of a stimulus from outside the system. An arduino can work with a system that functions to run the downloaded application, the performace of the program used.

This system works with a combination of inputs from outside the system which based on the combination of these inputs the designed system can make decisions.

*name of corresponding author



This is an ¹ Creative Commons License This work is licensed under a Creative Commons Attribution-NonCommercial 4.0 International License.

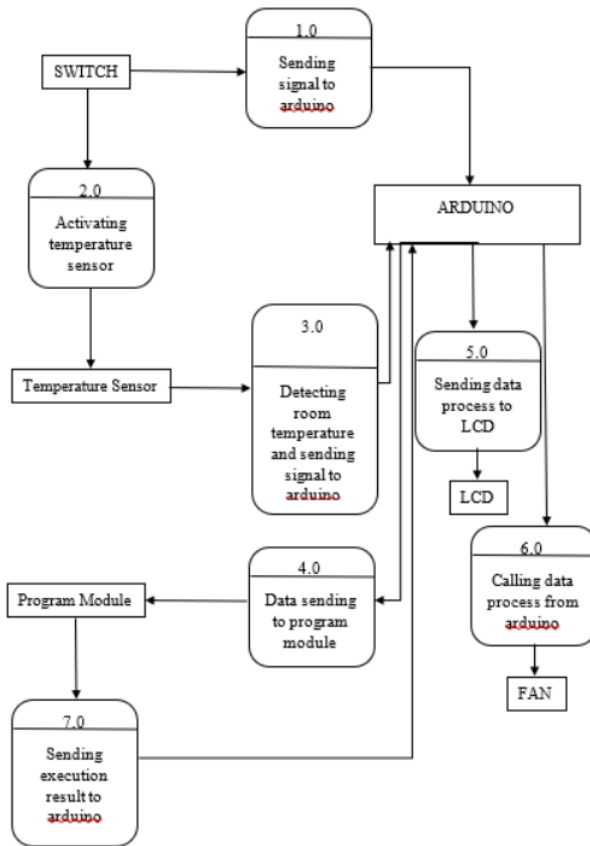

Program Module

This sub-chapter describes the program module for the application of a room temperature detection system using Arduino and LCD as output.

```

void loop()
{
  lcd.begin(16, 2);
  int adc = analogRead(0);
  //float suhu =(5.0 * adc * 102.0) / 1024.0;
  suhu=(5.0 * adc * 104.0)/1024.0;
  lcd.print(" TEMPERATUR ");
  lcd.setCursor (0, 1);
  lcd.print(suhu);
  lcd.print(myChar);
  lcd.print("C");
  if (suhu >= 34)
    digitalWrite(13,HIGH);
  else digitalWrite(13,LOW);
  delay(500);
}
  
```

RESULT

Arduino Circuit Testing

*name of corresponding author



This is an ¹ Creative Commons License This work is licensed under a Creative Commons Attribution-NonCommercial 4.0 International License.

Arduino Circuit Testing uses Arduino compiler software to create programs and download programs to Arduino circuits. Tests are also carried out to find out whether the Arduino module can work properly or not. This system will start working after the start button is pressed and the system will work automatically, where the system works without any control or control from outside the system, control of the entire system is carried out or controlled only through Arduino. Temperature settings are made in the program and the setting results will be displayed on the LCD and if the temperature is above the normal temperature limit, the fan will turn on.

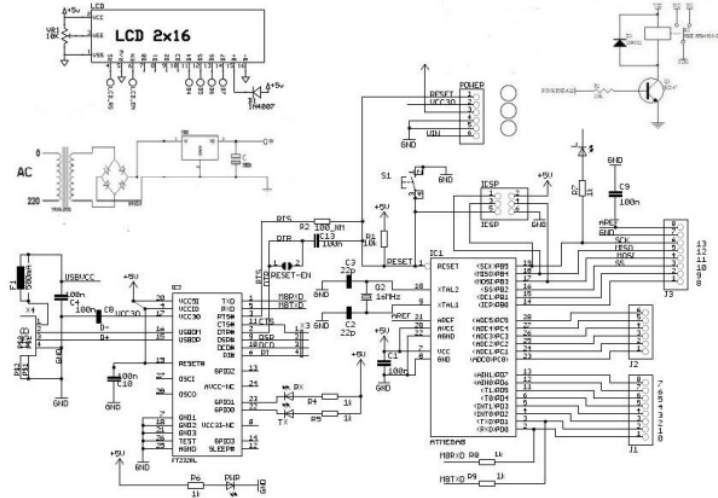

Fig.5. Arduino Test

Arduino Program Testing

This test aims to find out whether the Arduino program that will be uploaded to the Arduino Uno is correct. This test is done by means of Verify / Compile the program that has been made.

1. Type the syntax of the program in the Arduino software.

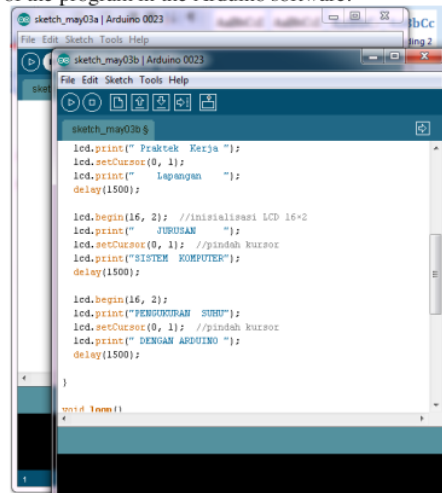

Fig.6. Program Syntax

2. After that, compile the program by clicking the sketch menu, and taking the Verify/Compile option, wait a moment.

*name of corresponding author



This is an Creative Commons License This work is licensed under a Creative Commons Attribution-NonCommercial 4.0 International License.

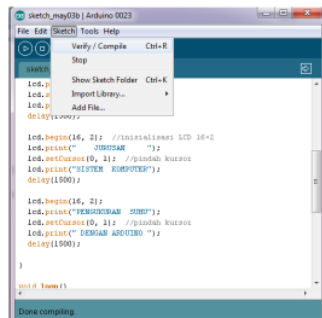

Fig.7. Compiling Program

3. Perform Board selection on the Arduino, and select the serial port detected by the PC

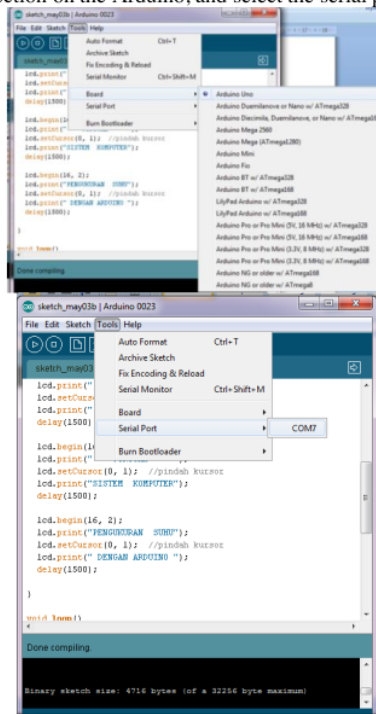

Fig.8. Board and Serial Port Selection

4. Upload the program to the Arduino uno board, select the file menu, select the upload to I/O board option. Wait until the upload process is complete, and do a system test.

*name of corresponding author



This is an ¹ Creative Commons License This work is licensed under a Creative Commons Attribution-NonCommercial 4.0 International License.

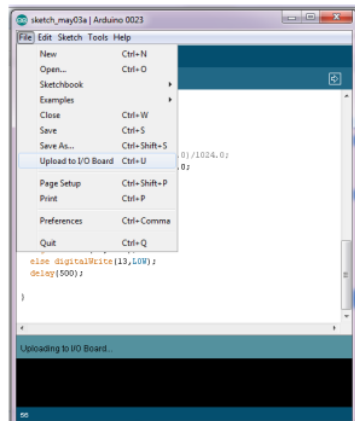
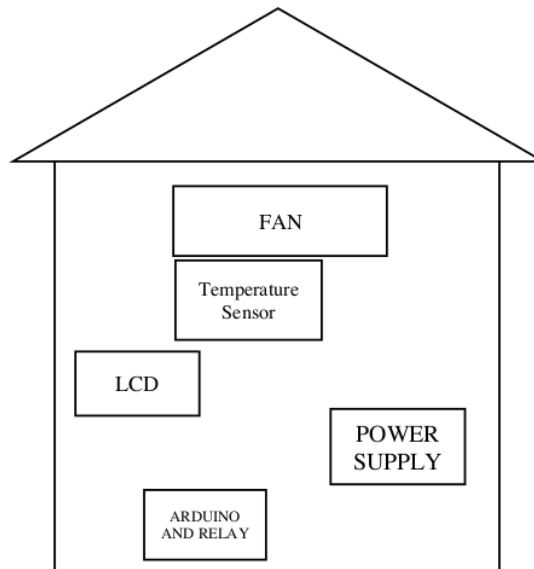

Fig.9. Upload the program to the Arduino board

Tool physical design



DISCUSSIONS

To determine the success of the system that has been designed, the results obtained are in accordance with those hypothesized at the beginning of the research, so that this system can find out how this system works in detecting room temperature. Many research results have been carried out, this can provide a variety of good perceptions and new, fresh idea in terms of system creation and allow for better updates and developments in the future.

CONCLUSION

¹⁴ Based on the description , it can be concluded that by utilizing a microcontroller programming using Arduino and the LM35DZ temperature sensor can be used to make a digital room temperature measuring device. The reading of the measurement results from the sensor can be displayed in real time via the LCD that has been connected to the Arduino. This research can be developed using a combination of other sensors so that the

*name of corresponding author



¹ This is an Creative Commons License This work is licensed under a Creative Commons Attribution-NonCommercial 4.0 International License.

influence of two measurement variables can be used such as temperature and humidity, temperature and color change, and so on.

ACKNOWLEDGMENT

Thank you to my family who want to support this research process which is very morally helpful, then to the other party I don't forget to say thank you to Universitas Putra Indonesia YPTK Padang for providing support in the form of motivation to write this article, and the publishers from the staff. editor. who received this article despite the careful selection process that led to this article being published.

REFERENCES

- 11 Adriansyah, A., & Hidayatama, O. (September 2013). *Elevator Prototype Design Using Arduino Atmega 328p Microcontroller*. Journal of Electrical Engineering Mercu University Buana, (Issn) Vol 4 No 3 2013
- 16 Al Bahra bin Ladjamudin. 2015. *Analysis and Design of Information Systems*. Yogyakarta : Graha Ilmu
- Albert Paul Malvino, 2013, *Principles of Electronics*, Salemba. Teknika, Jakarta
- Ardianto Pranata., Jaka Prayudha., Teja Sandi. (2017). *Detection Device Design Dehydration With Arduino Based Fuzzy Logic Method*. Journal of SAINTIKOM Vol.16, No. 3, September 2017 ISSN: 1978-6603
- Briston Manurung. (2019). *Design and Build a High Port Rate and Body Temperature Detector Arduino Uno Based Portable Microcontroller*. Medan. D-5 Physics Study Program, Faculty of Mathematics and Natural Sciences, University of North Sumatra. <http://repositori.usu.ac.id/handle/123456789/22599>
- Casely, D. and Kumar, K. 2010. *Monitoring and Evaluation of Projects in Agriculture*. Baltimore
- Eka Permana & Susi Herawati (2018), "DESIGN AND DEVELOPMENT OF ROOM TEMPERATURE MONITORING SYSTEM FOR WEB-BASED ORDERING SECTION USING ARDUINO UNO R3 MICROCONTROLLER", Journal of Information and Communication Technology STMIK Subang
- Eade and Williams, 2015, *The Oxfam Handbook of Development and Relief*, United Kingdom: Oxfam
- Rahayu, N. (2020). *Lpg Gas Leak Early Warning Via Short Message Service (Sms) And Loudspeaker Device Using Arduino Uno*. Journal of Applied Engineering and Technology Science (JAETS), 1(2), 91-102. <https://doi.org/10.37385/jaets.v1i2.6>
- Rindi Wulandari (2020), *Design of Arduino-Based Body Temperature Meter as a Covid-19 Early Detection Tool*, Proceedings of SNFA (National Seminar on Physics and Its Applications) 2020
- Navreetinder Kaur., Rita Mahajan., Deepak Bagai. (2016). *Air Quality Monitoring System Based on Arduino Microcontroller*. *International Journal of Innovative Research in Science, Engineering and Technology (ISO 3297:2007 Certified Organization)* vol. 5, Issue 6, June 2016
- Sumarna, E. 2015. *Designing and Building a Web-Based Remote Electrical Device Control System Using the Atmega8 Microcontroller*, the College of Informatics Management and Computer: Subang
- Yolnardi, et al (2020). *DESIGN AND DEVELOPMENT OF SPACE TEMPERATURE CONTROL BASED ON ARDUINO UNO MICROCONTROLLER*, Journal of Information Technology and Computer Science (INTECOMS)
- Zulhipni Reno Saputra Elsi (2016), *DESIGN OF ROOM TEMPERATURE MONITORING USING ANDROID-BASED ARDUINO AT PT. SINGLE BRANCH IDAMAN ABDI PALEMBANG, STMIK-MURA Lubuklinggau*

*name of corresponding author



This is an ¹ Creative Commons License This work is licensed under a Creative Commons Attribution-NonCommercial 4.0 International License.

Detection system with temperature in a room using Arduino

ORIGINALITY REPORT

22%

SIMILARITY INDEX

16%

INTERNET SOURCES

17%

PUBLICATIONS

%

STUDENT PAPERS

PRIMARY SOURCES

| | | |
|---|---|----|
| 1 | arrow.tudublin.ie Internet Source | 4% |
| 2 | Akmaludin Akmaludin, Frans Edward Schaduw, Heru Purwanto, Tri Hartati, Achmad Sumbaryadi. "Selection of Selected Flight Attendants Using MCDM-AHP and ELECTRE Method", SinkrOn, 2019 Publication | 4% |
| 3 | ejournal.unwaha.ac.id Internet Source | 3% |
| 4 | rigeo.org Internet Source | 2% |
| 5 | jurnal.uns.ac.id Internet Source | 2% |
| 6 | journal.ipm2kpe.or.id Internet Source | 1% |
| 7 | M Sesa, F Mahmuddin. "Development of Real-Time Monitoring System for an Off-Grid Photovoltaic System", IOP Conference Series: Earth and Environmental Science, 2021 | 1% |

| | | |
|----|--|------|
| 8 | mafiadoc.com Internet Source | 1 % |
| 9 | forum.arduino.cc Internet Source | 1 % |
| 10 | www.scitepress.org Internet Source | <1 % |
| 11 | Rikha Widiaratih, Agus Anugroho Dwi Suryoputra, Gentur Handoyo, Alfi Satriadi, Ari Bawono Putranto. "Prototype of simple mini-wave gauge using Microcontroller ESP32 on the laboratory scale", IOP Conference Series: Earth and Environmental Science, 2023 Publication | <1 % |
| 12 | K. Cornelius, N. Komal Kumar, Sagar Pradhan, Priyesh Patel, N. Vinay. "An Efficient Tracking System for Air and Sound Pollution using IoT", 2020 6th International Conference on Advanced Computing and Communication Systems (ICACCS), 2020 Publication | <1 % |
| 13 | www.coursehero.com Internet Source | <1 % |
| 14 | www.koreascience.or.kr Internet Source | <1 % |
| 15 | publikasi.ildikti10.id Internet Source | |

<1 %

16

Yolnasdi Yolnasdi, Arviansyah Arviansyah, Dedy Irfan, Ambiyar Ambiyar. "Rancang Bangun Pengontrol Suhu Ruangan Berbasis Mikrokontroler Arduino Uno", INTECOMS: Journal of Information Technology and Computer Science, 2020

Publication

<1 %

17

"Merged Papers", 2020 7th International Conference on Smart Structures and Systems (ICSSS), 2020

Publication

<1 %

Exclude quotes Off

Exclude matches Off

Exclude bibliography Off